

# DEEP SPACE NINE

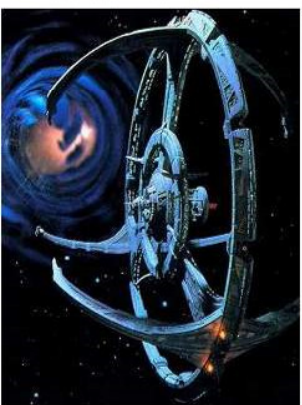

Thank for downloading this paper model of "Deep Space Nine" (or "Terok Nor" as the Cardassians like to call it) from <http://members.lycos.nl/ninjatoes/index.html>. This model obviously isn't an exact replica of the station, but it's as close as I could get it; the scale is about 1:5000 when printed fit to page (should be about 89%).

Have fun building, and don't forget to let me know what you think of it at [ninjatoes@lycos.nl](mailto:ninjatoes@lycos.nl)  
greetz ninjatoes

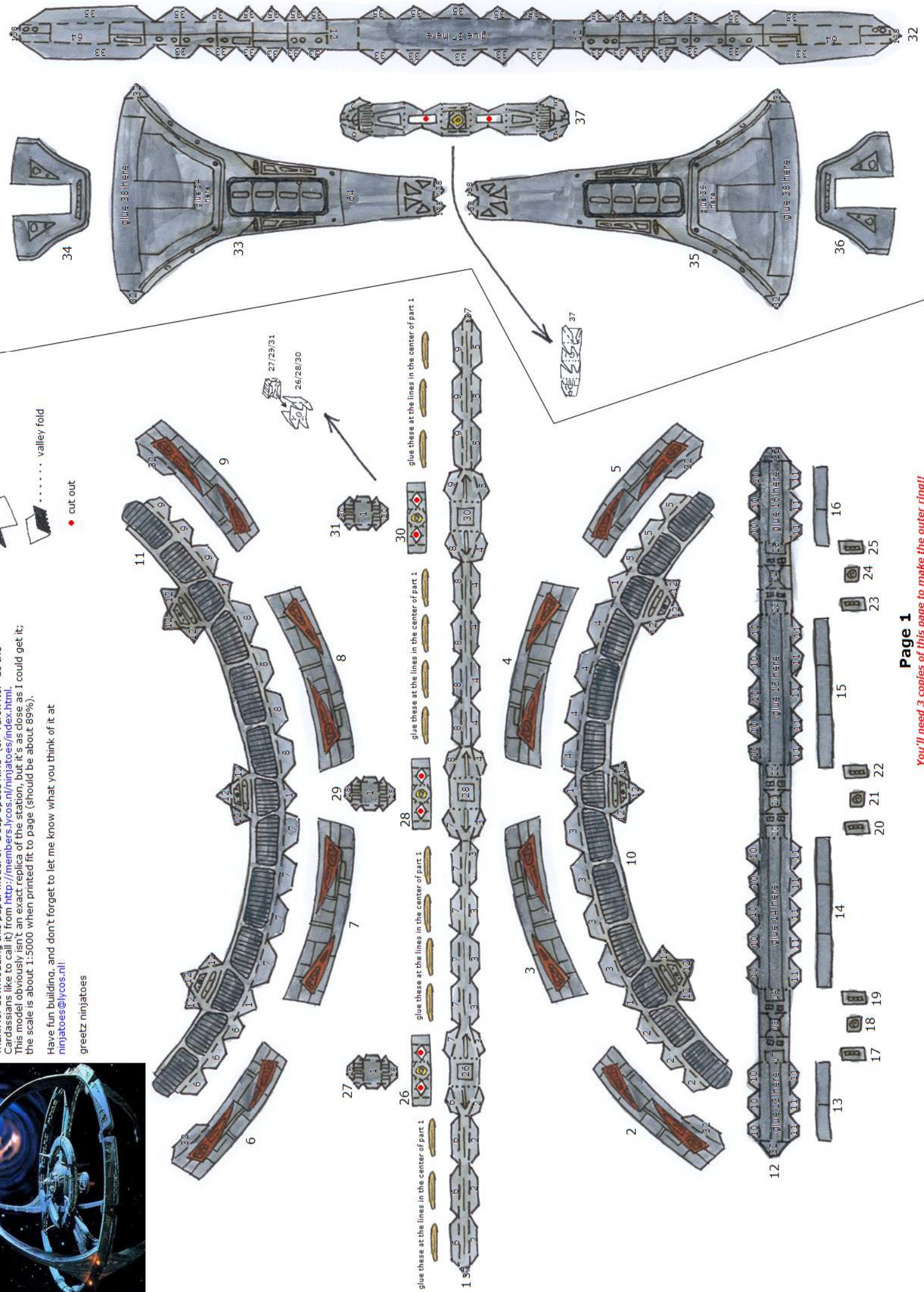
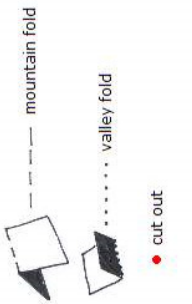

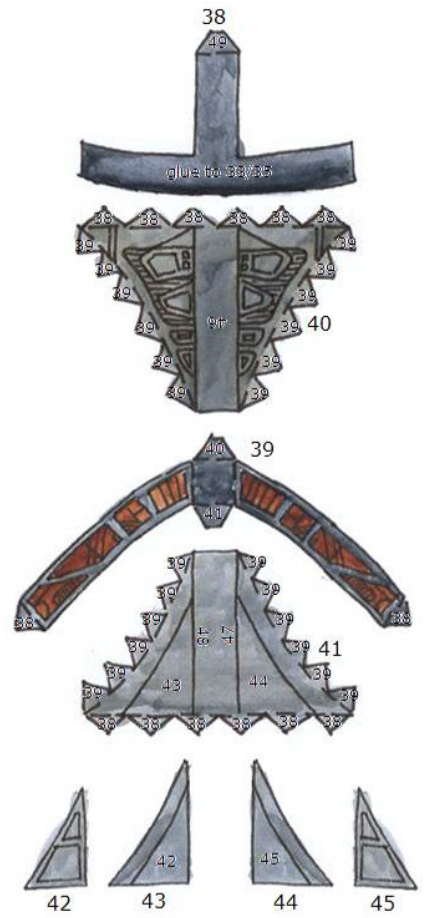
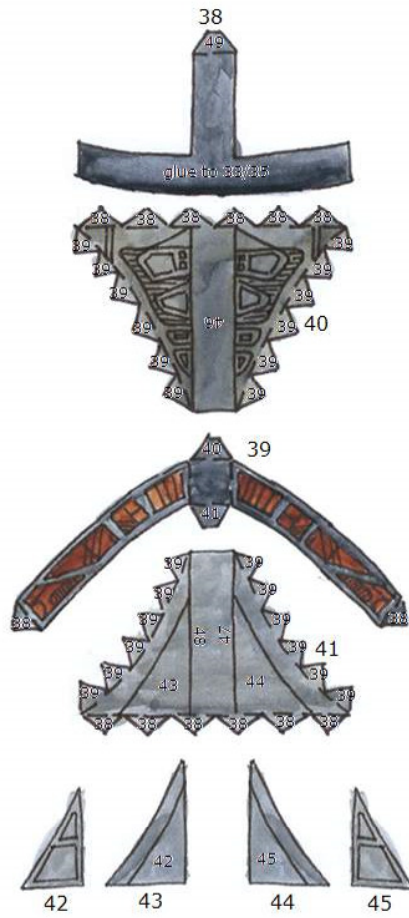
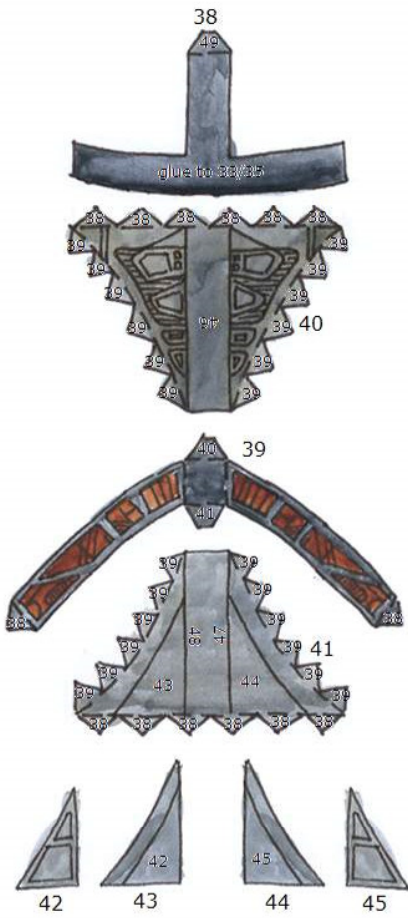
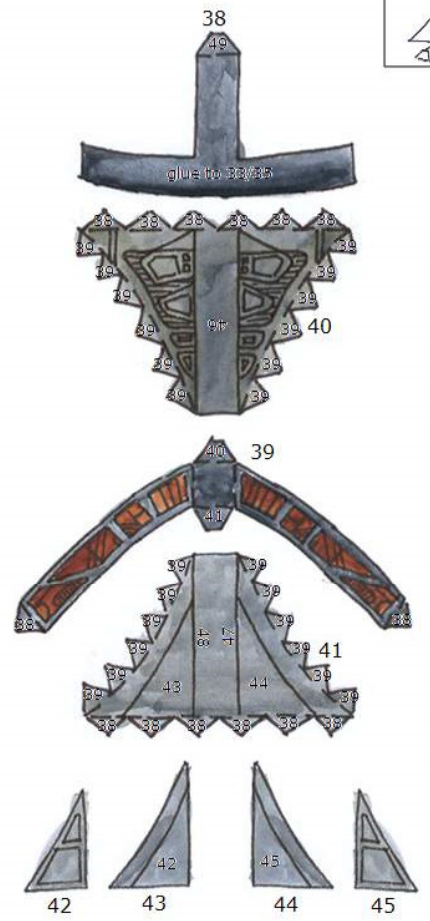
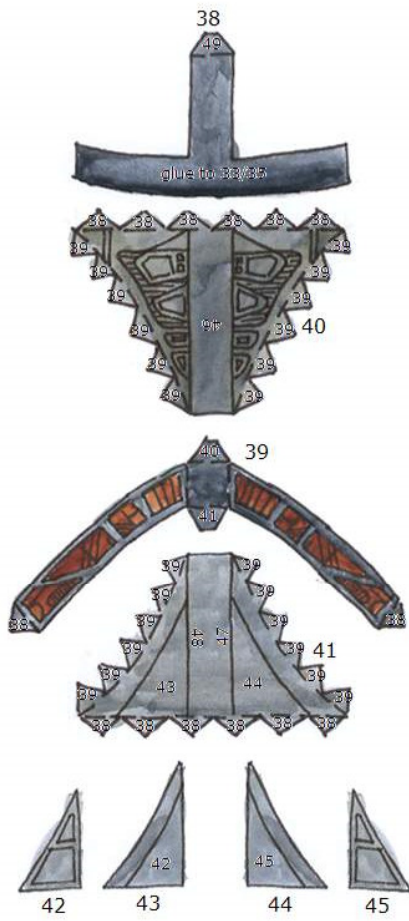
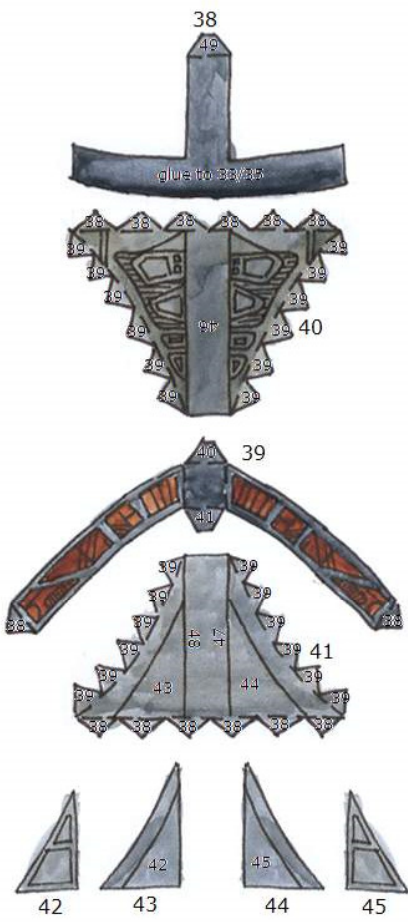

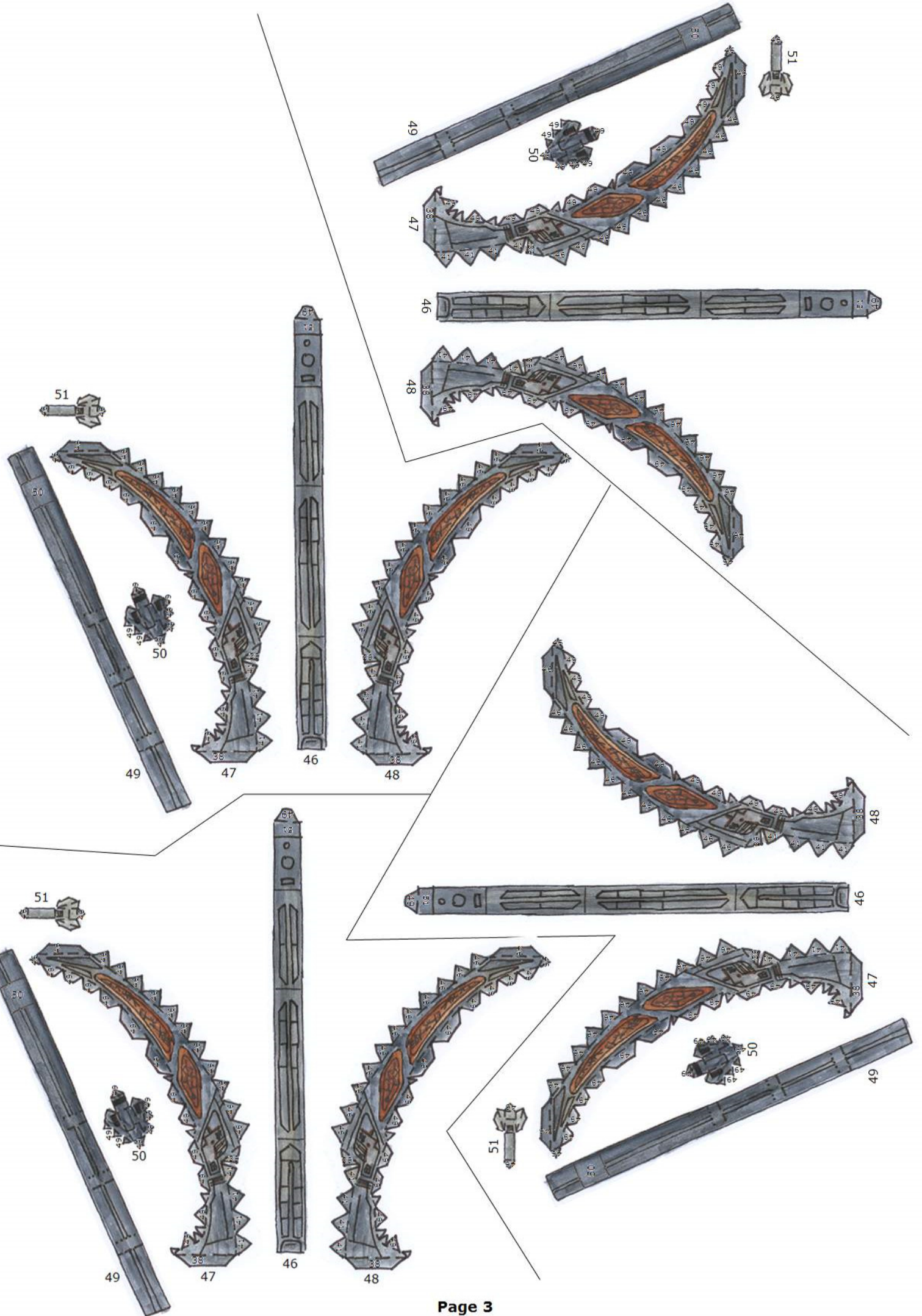

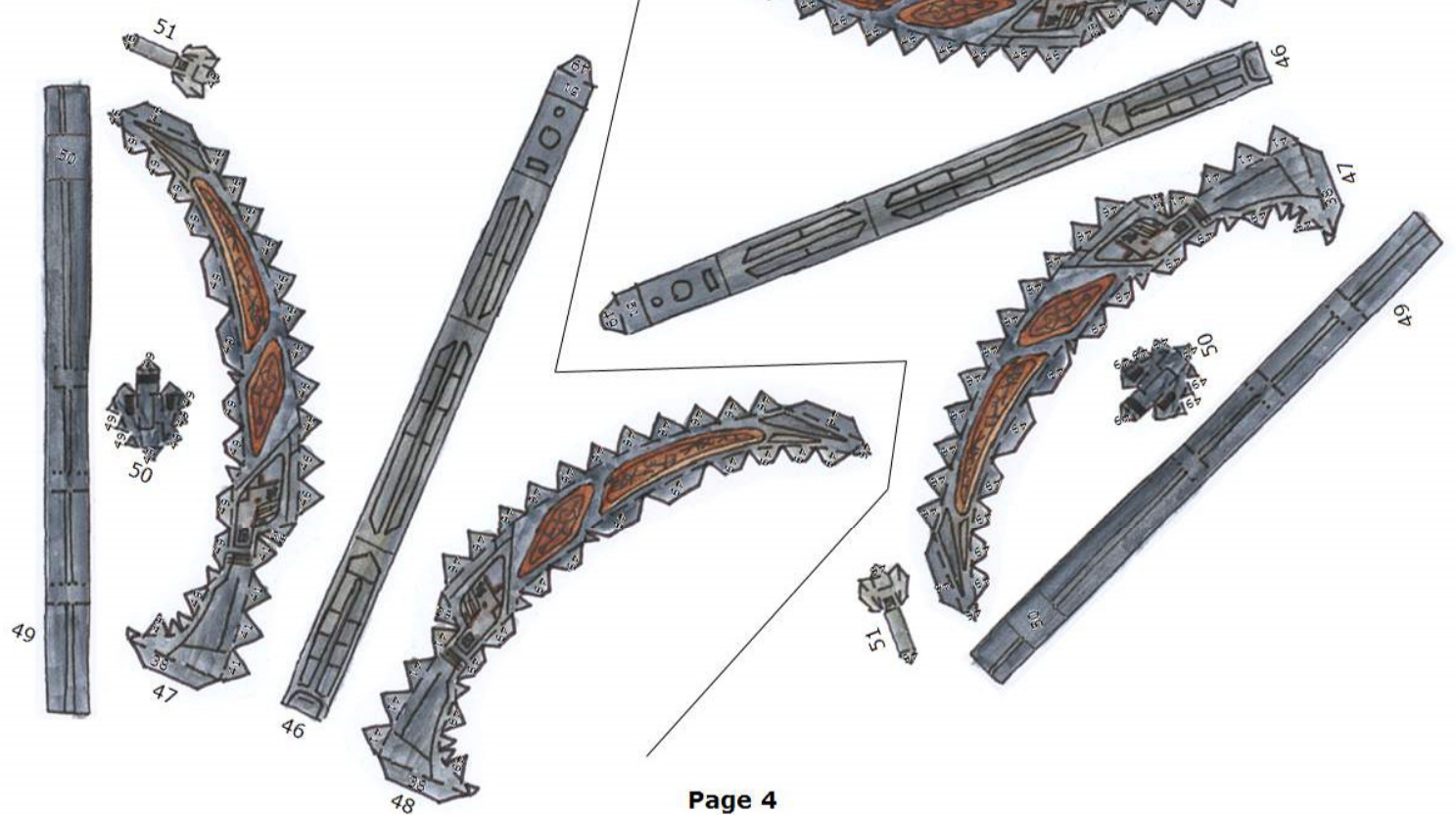
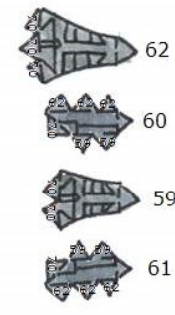
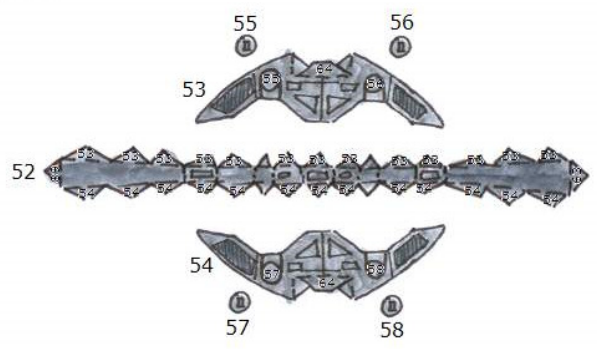
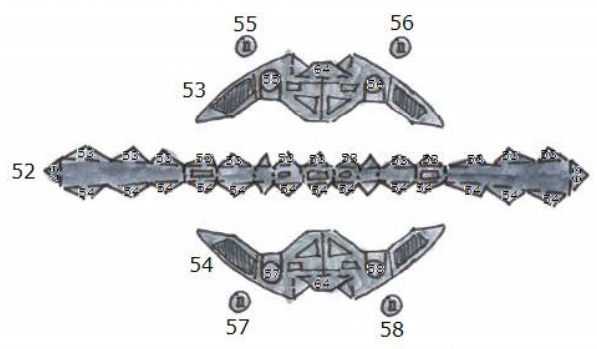
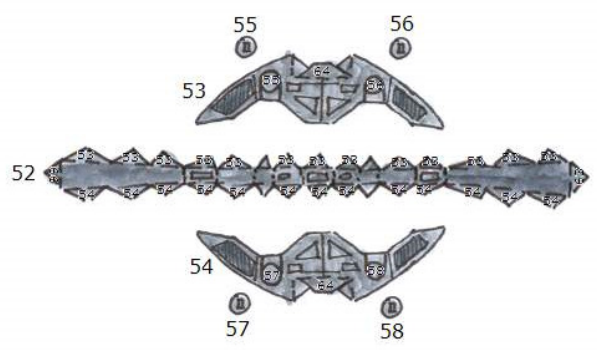

glue these at the spaces marked "\*" on part 64

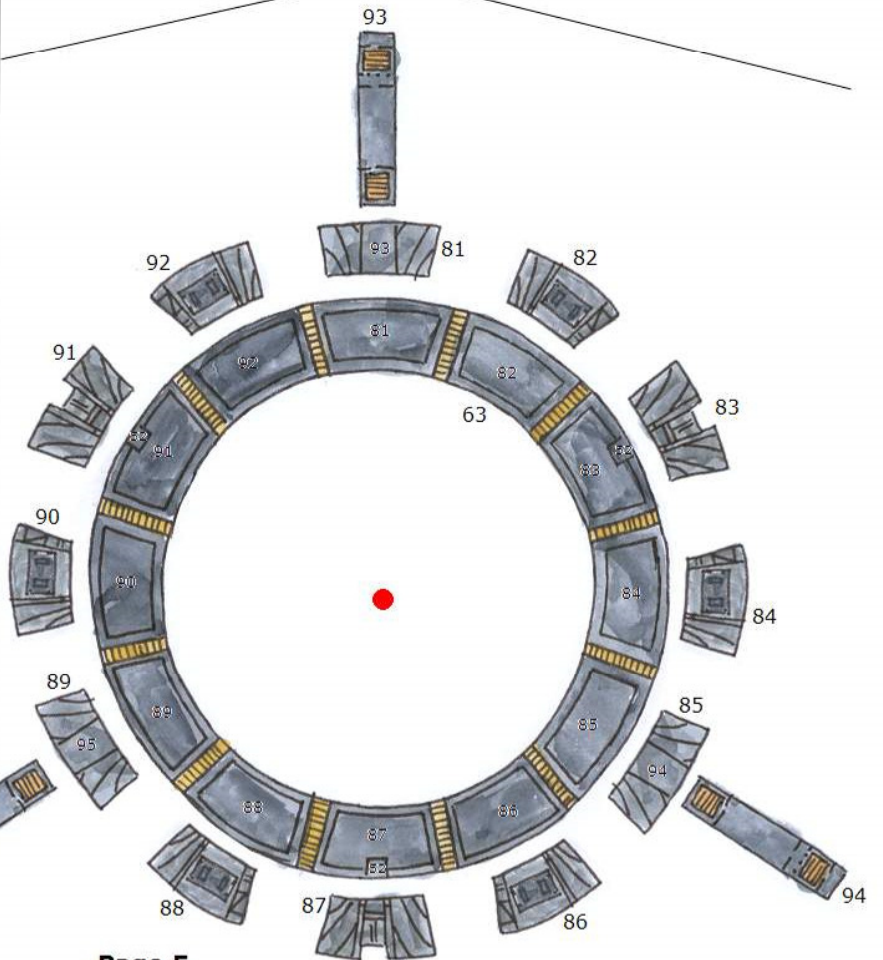
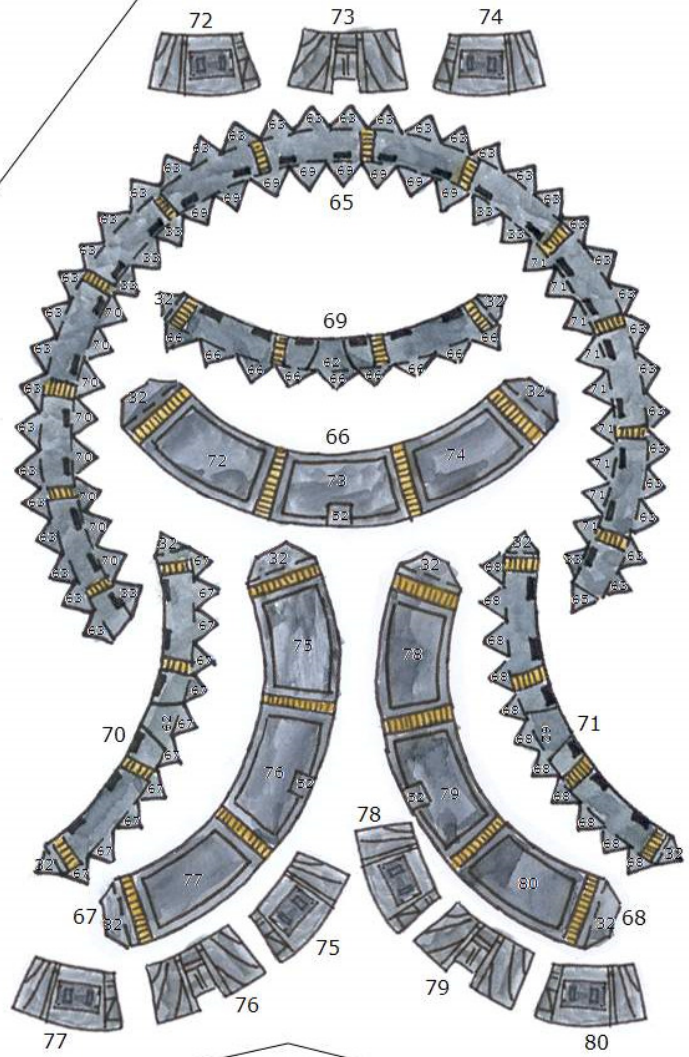
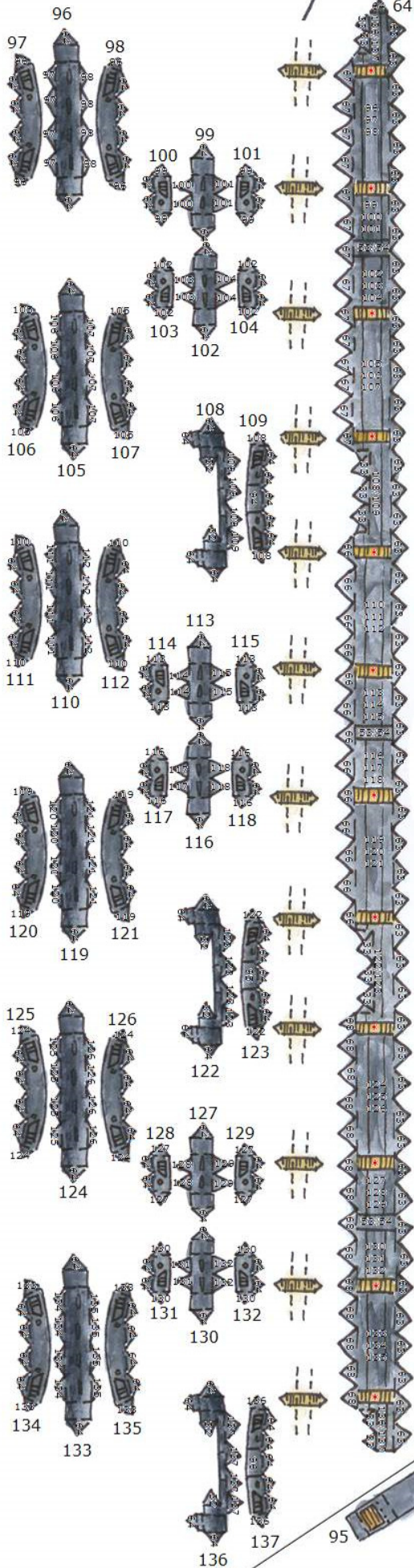

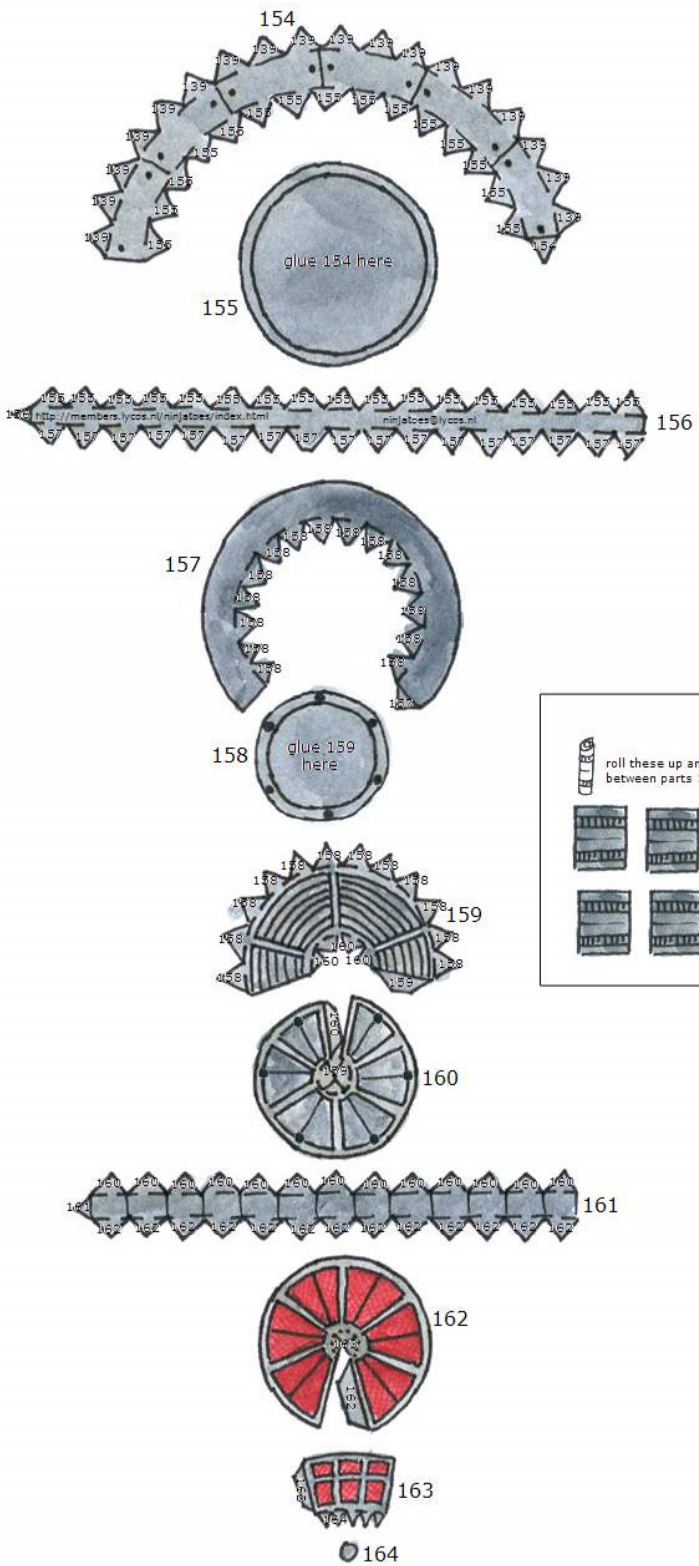
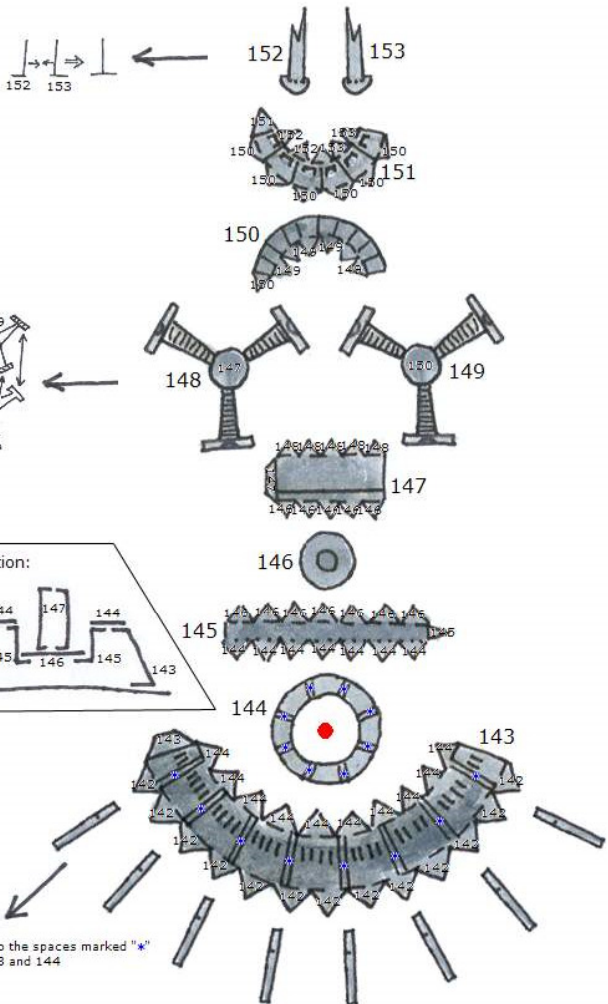



I



Cut out parts I and II and glue them together on some thicker piece of cardboard to make a display for your paper model of the Star Trek "Deep Space Nine" space station.



II

glue part I here